



Cambridge IGCSE™

CANDIDATE
NAME

--

CENTRE
NUMBER

--	--	--	--	--

CANDIDATE
NUMBER

--	--	--	--



PHYSICS

0625/43

Paper 4 Theory (Extended)

October/November 2023

1 hour 15 minutes

You must answer on the question paper.

No additional materials are needed.

INSTRUCTIONS

- Answer **all** questions.
- Use a black or dark blue pen. You may use an HB pencil for any diagrams or graphs.
- Write your name, centre number and candidate number in the boxes at the top of the page.
- Write your answer to each question in the space provided.
- Do **not** use an erasable pen or correction fluid.
- Do **not** write on any bar codes.
- You may use a calculator.
- You should show all your working and use appropriate units.
- Take the weight of 1.0 kg to be 9.8 N (acceleration of free fall = 9.8 m/s^2).

INFORMATION

- The total mark for this paper is 80.
- The number of marks for each question or part question is shown in brackets [].

This document has **16** pages. Any blank pages are indicated.

- 1 (a) Oil of density 0.80 g/cm^3 is poured gently onto the surface of water of density 1.0 g/cm^3 . The oil and the water do **not** mix.

Describe and explain the final position of the oil relative to the water.

description

.....

explanation

.....

[2]

- (b) An irregularly shaped solid object has a density of 2.7 g/cm^3 .

(i) Describe a method to measure the volume of the irregularly shaped solid object.

.....

.....

..... [2]

(ii) The volume of the object is 83 cm^3 .

Calculate the mass of the object.

mass = [3]

[Total: 7]

- 2 (a) Fig. 2.1 is a graph that shows how the extension of a spring varies with the load suspended from it.

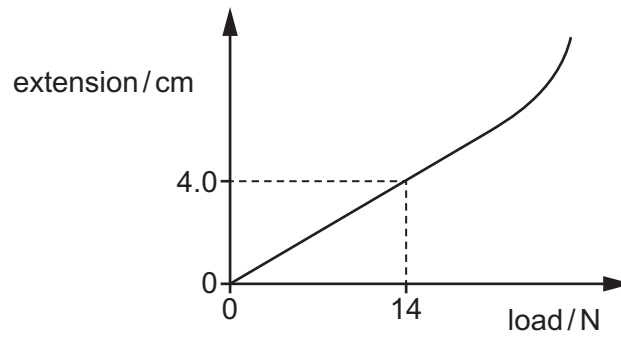

Fig. 2.1

- (i) Determine the spring constant of this spring.

spring constant = [3]

- (ii) On Fig. 2.1, mark the limit of proportionality and label this point L. [1]

- (b) Fig. 2.2 shows a car travelling at constant speed around corner A on a road.

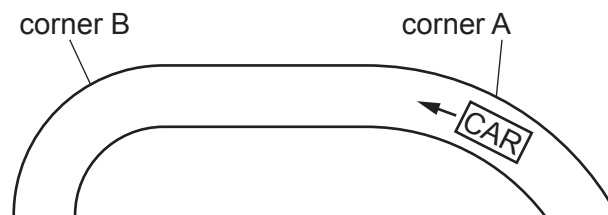

Fig. 2.2

- (i) On Fig. 2.2, mark with an arrow the direction of the resultant force acting on the car as it travels around corner A. [2]
- (ii) Corner B has a smaller radius than corner A. The car travels at the same speed around corner B as around corner A.

State how the resultant force changes due to the car travelling around a corner of smaller radius.

..... [1]

[Total: 7]

- 3 Fig. 3.1 shows a boy throwing a ball at an object in a fairground.

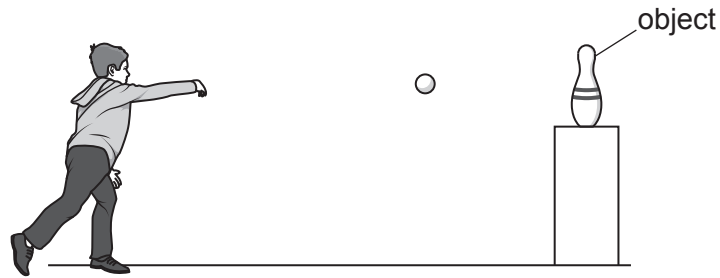

Fig. 3.1

The ball has a mass of 190 g and travels horizontally with a constant speed of 6.9 m/s.

- (a) Calculate the momentum of the ball.

momentum = [2]

- (b) After hitting the object, the ball bounces back along the same straight path with a speed of 1.5 m/s. The object has a mass of 1.8 kg.

Calculate the speed of the object after it is hit by the ball.

speed = [3]

(c) The kinetic energy of the ball is 4.5 J before the collision and 0.2 J after the collision.

Calculate the change in total kinetic energy of the ball and object during the collision.

change in total kinetic energy = [3]

[Total: 8]

4 (a) The lowest possible temperature is zero kelvin (0K).

(i) State the name of this lowest possible temperature.

..... [1]

(ii) Nitrogen boils at 77K.

Calculate the boiling point of nitrogen on the Celsius scale.

boiling point = °C [2]

(b) The temperature of a fixed mass of gas at constant volume changes from 300 K to 400 K.

State and explain, in terms of particles, the effect on the pressure of the gas.

statement

explanation

.....

.....

.....

[4]

(c) A sample of gas is at a pressure of 120kPa. The volume of the gas is doubled at constant temperature.

Calculate the new pressure of the gas.

pressure = [2]

[Total: 9]

- 5 (a) Fig. 5.1 is a scale diagram of wavefronts of red light approaching a gap in a barrier.

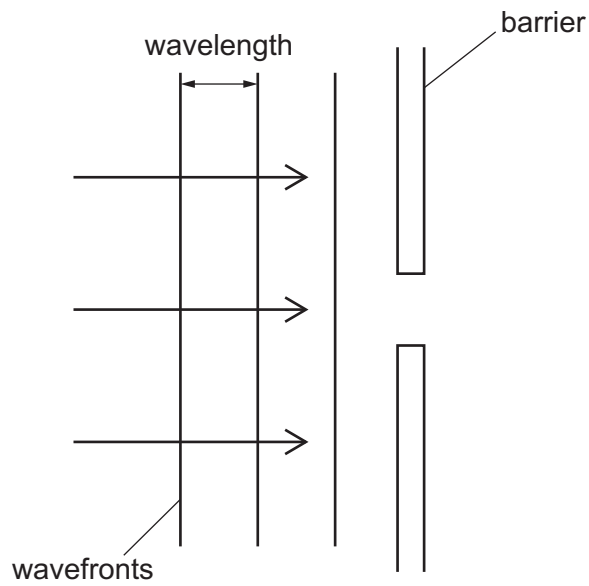

Fig. 5.1

On Fig. 5.1, draw **three** wavefronts after the wave has passed through the gap. [3]

- (b) Fig. 5.2 shows the same barrier and gap. A wave of blue light approaches this barrier.

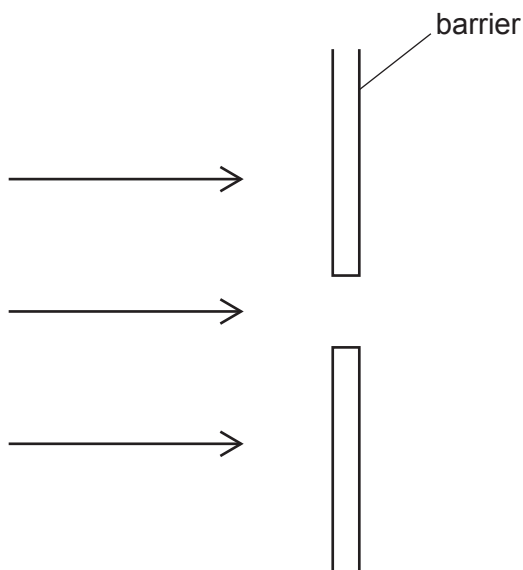

Fig. 5.2

On Fig. 5.2:

- draw **three** wavefronts of this wave before it reaches the barrier
- draw **three** wavefronts after the wave passes through the gap.

[3]

[Total: 6]

6 (a) On Fig. 6.1, sketch the current–voltage graph of a filament lamp and explain its shape.



Fig. 6.1

explanation

.....

[3]

(b) Fig. 6.2 shows an electric circuit.

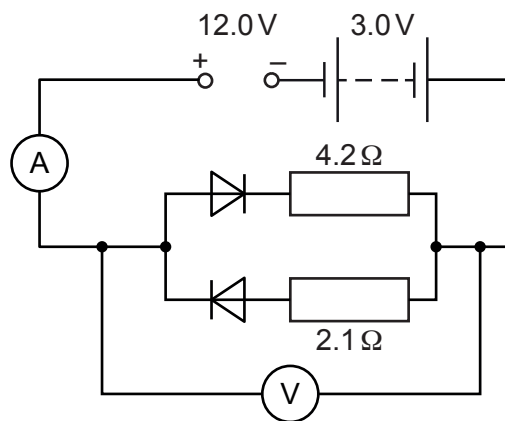

Fig. 6.2

(i) Calculate the reading on the voltmeter.

voltmeter reading = [2]

(ii) Calculate the current in the $4.2\ \Omega$ resistor.

current = [2]

(iii) Determine the current in the $2.1\ \Omega$ resistor.

current = [1]

(iv) Determine the reading on the ammeter.

ammeter reading = [1]

(v) Calculate the electrical power transferred in the $4.2\ \Omega$ resistor.

power = [2]

[Total: 11]

7 (a) Fig. 7.1 shows the electric field pattern around point X.

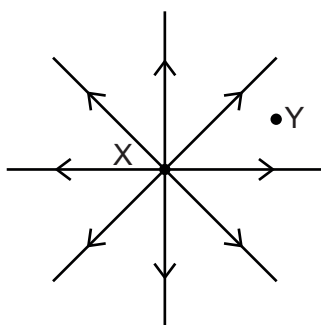

Fig. 7.1

(i) On Fig. 7.1, draw an arrow to indicate the direction of the force on a negative point charge placed at point Y. [2]

(ii) State what is at point X to produce the field pattern shown in Fig. 7.1.

.....
 [2]

(b) A piece of plastic is charged positively by friction.

State what charge transfers occur during this process.

.....

 [2]

(c) Explain how the structure of an electrical conductor differs from the structure of an electrical insulator.

.....
 [2]

[Total: 8]

8 (a) Fig. 8.1 shows the single turn coil of a simple direct current (d.c.) motor.

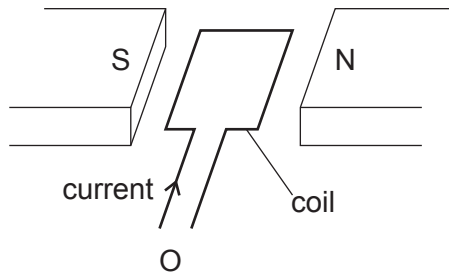

Fig. 8.1

(i) Explain the direction of the turning effect as seen by an observer at O.

.....

 [2]

(ii) The coil is replaced by an otherwise identical new coil with three turns and the same current in the coil.

State how the turning effect compares with the turning effect in (i).

..... [1]

(iii) A third coil is identical to the coil in (i) except that its resistance is three times greater. The potential difference (p.d.) across the coil is the same as the p.d. in (i).

State how the turning effect compares with the turning effect in (i).

..... [1]

- (b) Fig. 8.2 is a voltage–time graph showing the output of a simple alternating current (a.c.) generator at times t_0 , t_1 , t_2 and t_3 .

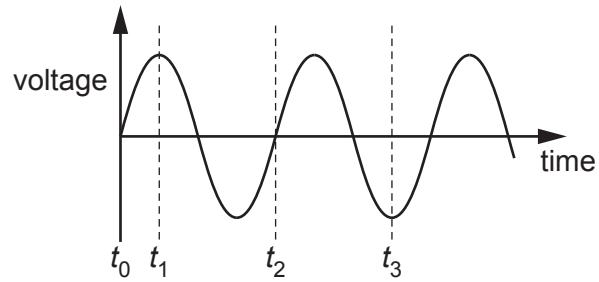

Fig. 8.2

Fig. 8.3 is an end view of the plane of the coil of the generator at time t_0 . The coil is rotating clockwise.

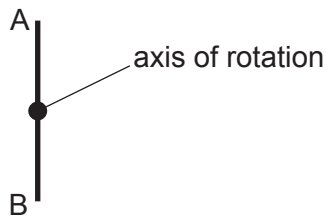

Fig. 8.3

- (i) Draw an end view of the position of the plane of the coil at time t_1 . Include the labels A and B.

[1]

- (ii) Draw an end view of the position of the plane of the coil at time t_2 . Include the labels A and B.

[1]

- (iii) Draw an end view of the position of the plane of the coil at time t_3 . Include the labels A and B.

[1]

[Total: 7]

9 (a) For each application of radioactive isotopes, state and explain which type of radioactive emission is suitable and suggest an appropriate half-life for the isotope.

(i) household smoke alarm

type of radioactive emission

explanation

.....

half-life

[3]

(ii) measuring the thickness of aluminium strips produced in a factory

type of radioactive emission

explanation

.....

half-life

[3]

(b) Lead-208 ($^{208}_{82}\text{Pb}$) has the highest nucleon number of the stable isotopes of lead.

Explain why lead-214 ($^{214}_{82}\text{Pb}$) is radioactive.

.....

.....

.....

..... [2]

(c) State **two** different sources of background radiation.

1

2

[2]

[Total: 10]

- 10 (a) (i) 1. State what is represented in space physics by the symbol H_0 .
..... [1]
2. Write down the equation that defines H_0 in terms of the speed that a far galaxy is moving away from the Earth and its distance from the Earth.
..... [1]
- (ii) The numerical value of H_0 is 2.2×10^{-18} . State the unit of H_0 .
..... [1]
- (iii) Use this value of H_0 to determine an estimate for the age of the Universe in seconds.

age of the Universe = s [2]

- (b) State when cosmic microwave background radiation (CMBR) was formed and where we detect it coming from.
.....
.....
.....
..... [2]

[Total: 7]

BLANK PAGE

Permission to reproduce items where third-party owned material protected by copyright is included has been sought and cleared where possible. Every reasonable effort has been made by the publisher (UCLES) to trace copyright holders, but if any items requiring clearance have unwittingly been included, the publisher will be pleased to make amends at the earliest possible opportunity.

To avoid the issue of disclosure of answer-related information to candidates, all copyright acknowledgements are reproduced online in the Cambridge Assessment International Education Copyright Acknowledgements Booklet. This is produced for each series of examinations and is freely available to download at www.cambridgeinternational.org after the live examination series.

Cambridge Assessment International Education is part of Cambridge Assessment. Cambridge Assessment is the brand name of the University of Cambridge Local Examinations Syndicate (UCLES), which is a department of the University of Cambridge.