



Cambridge IGCSE™

CANDIDATE
NAME

CENTRE
NUMBER

--	--	--	--	--

CANDIDATE
NUMBER

--	--	--	--



MATHEMATICS

0580/32

Paper 3 (Core)

October/November 2023

2 hours

You must answer on the question paper.

You will need: Geometrical instruments

INSTRUCTIONS

- Answer **all** questions.
- Use a black or dark blue pen. You may use an HB pencil for any diagrams or graphs.
- Write your name, centre number and candidate number in the boxes at the top of the page.
- Write your answer to each question in the space provided.
- Do **not** use an erasable pen or correction fluid.
- Do **not** write on any bar codes.
- You should use a calculator where appropriate.
- You may use tracing paper.
- You must show all necessary working clearly.
- Give non-exact numerical answers correct to 3 significant figures, or 1 decimal place for angles in degrees, unless a different level of accuracy is specified in the question.
- For π , use either your calculator value or 3.142.

INFORMATION

- The total mark for this paper is 104.
- The number of marks for each question or part question is shown in brackets [].

This document has **16** pages.

1 (a) The bar chart shows the number of goals scored by a team in each of 5 months.

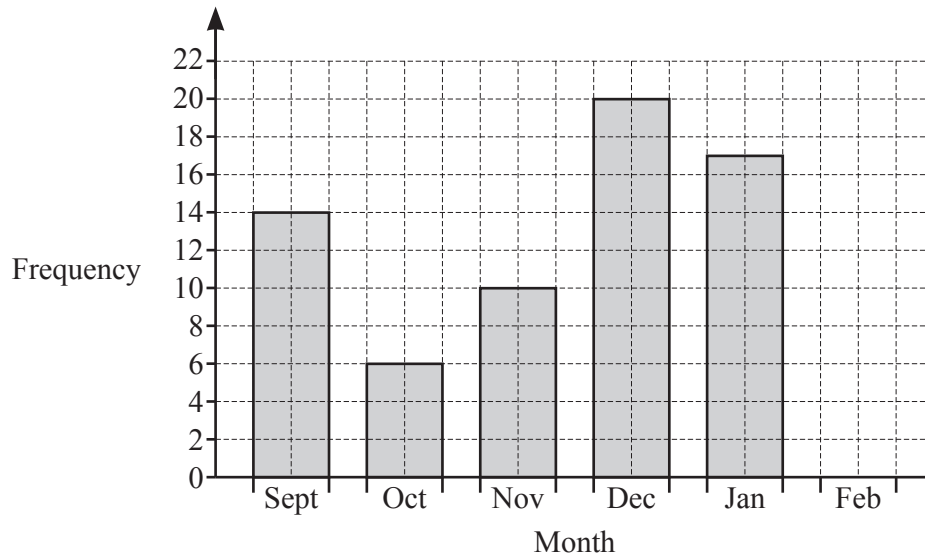

(i) In February, 12 goals are scored.

Complete the bar chart.

[1]

(ii) How many more goals were scored in January than in October?

..... [1]

(b) Find the range of the number of goals scored.

..... [1]

(c) (i) The team shop is open from 09 00 to 17 15 on Monday to Friday only.

Work out how long the shop is open each week.
Give your answer in hours and minutes.

..... h min [3]

(ii) Bruno buys a shirt for \$36 and a scarf for \$12.25 .
He pays with a \$50 note.

Work out how much change he receives.

\$ [2]

(d)

<u>Ticket prices</u>	
Adult	\$35
Child	\$20
Senior	\$25

(i) Calculate the cost of 150 adult tickets, 70 child tickets and 30 senior tickets.

\$ [3]

(ii) Calculate the percentage of these tickets that are senior tickets.

..... % [2]

(e) A game starts at 15 00.
The team plays for 90 minutes.
There is also a break of 15 minutes.

Find the time the game ends.

..... [2]

2 (a) (i)

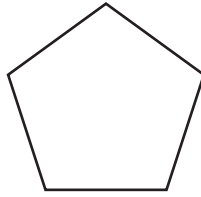

Write down the mathematical name for this polygon.

..... [1]

(ii)

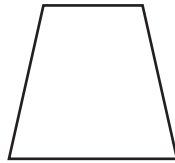

Write down the mathematical name for this quadrilateral.

..... [1]

(iii)

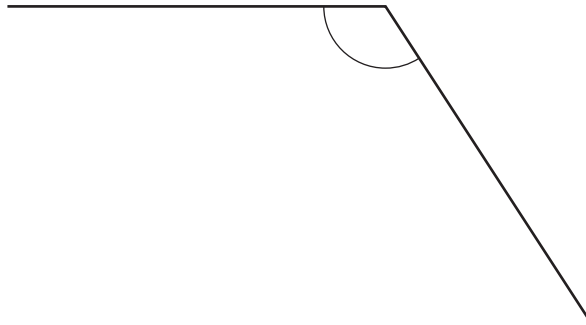

(a) Write down the mathematical name for this type of angle.

..... [1]

(b) Measure the size of this angle.

..... [1]

(b)



Draw the lines of symmetry on this rectangle.

[2]

(c) A cuboid measures 6 cm by 3 cm by 2 cm.

(i) Work out the volume of the cuboid.

..... cm^3 [1]

(ii) Draw a net of the cuboid on the 1 cm^2 grid.
One face has been drawn for you.

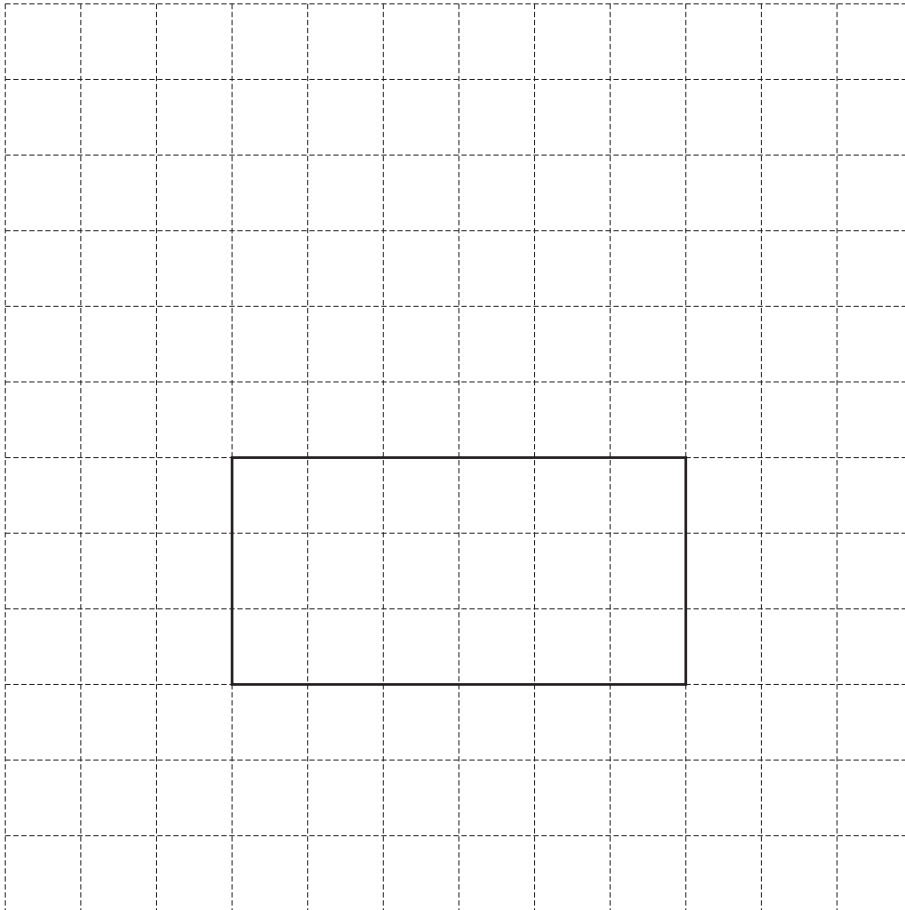

[3]

- 3 (a) Write the number fourteen thousand and ninety-seven in figures.

..... [1]

- (b) Write down a common multiple of 17 and 5.

..... [1]

- (c) Write 0.25 as a percentage.

..... % [1]

- (d) Find the value of

(i) 7^5

..... [1]

(ii) 8^0 .

..... [1]

- (e) Ranjit buys some plants and sells $\frac{5}{11}$ of them.
He sells 190 plants.

Work out how many plants he buys.

..... [2]

- (f) Factorise completely.

$$15x^3y - 3x$$

..... [2]

- (g) Make n the subject of the formula $V = 3n + t$.

$n =$ [2]

(h) $7^{15} \div 7^x = 7^9$

Find the value of x .

$x =$ [1]

- 4 (a) Complete the table of values for $y = x^2 - 4x - 2$.

x	-2	-1	0	1	2	3	4	5
y		3	-2	-5		-5	-2	3

[2]

- (b) On the grid, draw the graph of $y = x^2 - 4x - 2$ for $-2 \leq x \leq 5$.

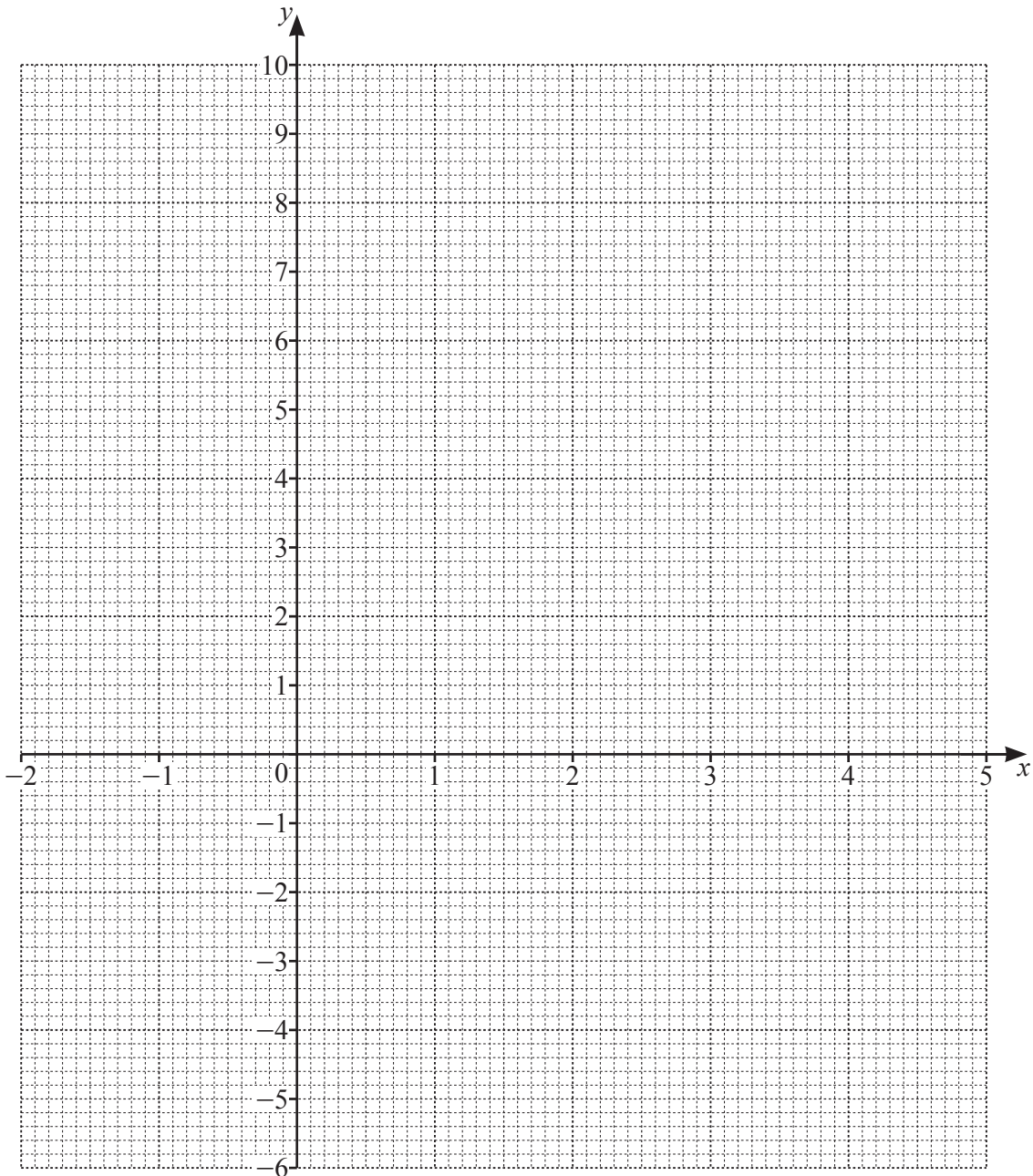

[4]

- (c) Use your graph to solve the equation $x^2 - 4x - 2 = 0$.

$x = \dots\dots\dots$ or $x = \dots\dots\dots$ [2]

- 5 Heidi records the colour of each of 500 cars crossing a bridge. The pie chart shows some of this information.

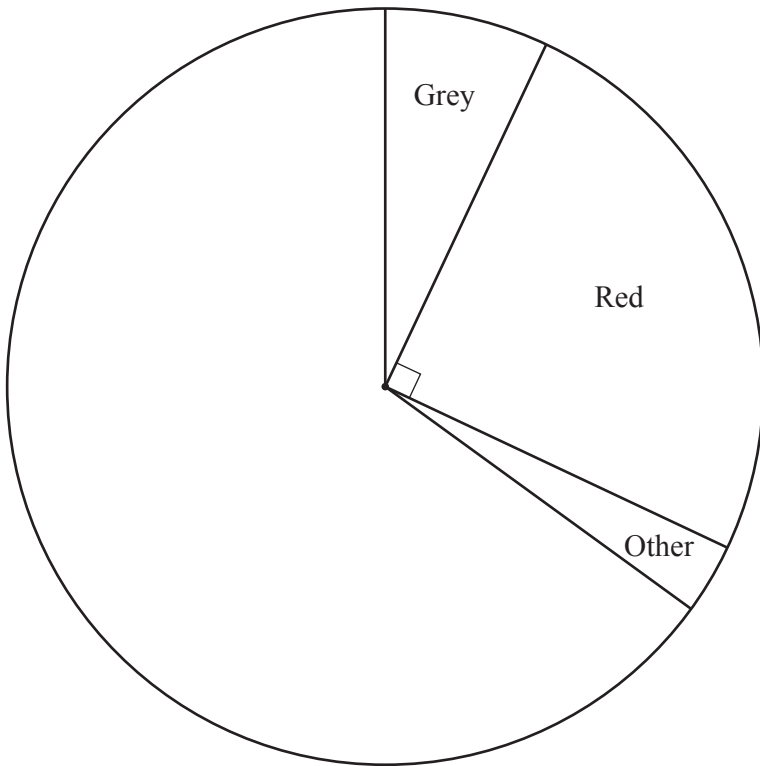

- (a) How many cars are red?

..... [1]

- (b) 35 cars are grey.

Show, by calculation, that the sector angle for grey is 25.2° .

[1]

- (c) 175 cars are white and 150 cars are black.

Complete the pie chart to show this information.

[2]

- (d) Find the probability that a car chosen at random is **not** grey.

Give your answer as a fraction in its simplest form.

..... [2]

- (e) Another 320 cars cross the bridge.

How many of these 320 cars are expected to be white?

..... [2]

- (f) Heidi also records the number of people in each car crossing the bridge for one hour.

Number of people	Frequency
1	20
2	6
3	0
4	15
5	8
6	12

Calculate the mean.

..... [3]

- 6 (a) Simplify.
 $a + 4a - 3a$

..... [1]

- (b) Simplify.
 $8b - 4 \times 7b$

..... [1]

- (c)

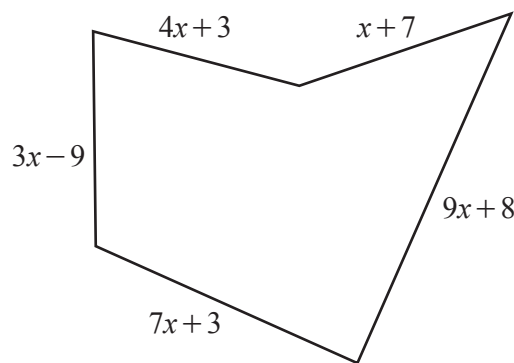

NOT TO
SCALE

The perimeter of this shape is equal to the perimeter of a square.

Find an expression for the length of one side of the square.
 Give your answer in its simplest form.

..... [4]

- (d) Victoria buys 5 cups of tea and 4 cakes for \$15.69 .
Isabella buys 3 cups of tea and 7 cakes for \$17.97 .

Write down a pair of simultaneous equations and solve them to find the cost of one cup of tea and the cost of one cake.

You must show all your working.

Tea \$

Cake \$ [6]

7 Elize, Lily and Marco start a business.

- (a) Elize invests \$5000.
 Lily invests \$8000.
 Marco invests \$3000.

After one year they make a profit of \$40 000.
 They share this profit in the ratio of their investments.

Work out how much they each receive.

Elize \$
 Lily \$
 Marco \$ [3]

- (b) (i) Lily buys 20 rolls of ribbon.
 8 are red, 6 are blue, 4 are yellow and 2 are pink.
 A roll of ribbon is chosen at random.

On the probability scale, draw an arrow (\downarrow) to show the probability that this roll is

- (a) yellow

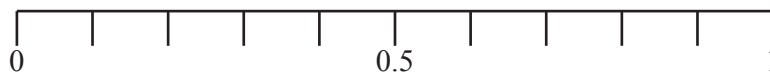

[1]

- (b) not red

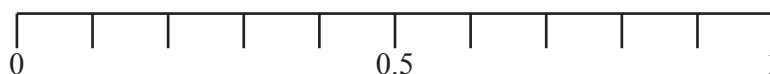

[1]

- (c) green.

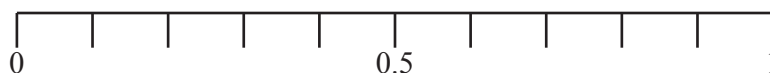

[1]

- (ii) The length, l m, of a roll of ribbon is 120 m, correct to the nearest metre.

Complete this statement about the value of l .

..... $\leq l <$ [2]

- (c) Elize buys some picture frames.
 The frames cost \$5.80 each in New York and 4.50 euros each in Paris.
 The exchange rate is 1 euro = \$1.37 .

Calculate the difference in the cost in euros.
 Give your answer correct to 2 decimal places.

..... euros [3]

- (d) Elize buys a framed picture.

(i)

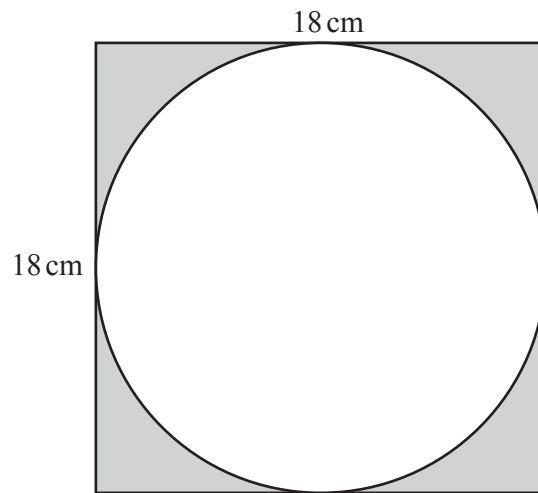

NOT TO
SCALE

The picture is a circle with diameter 18 cm.
 The frame is a square of side length 18 cm.

Calculate the shaded area.

..... cm² [3]

- (ii) Elize buys the framed picture for \$12.50 .
 She sells the framed picture for \$20.25 .

Calculate the percentage profit.

..... % [2]

8 (a) In triangle RST , $RT = 7$ cm and $ST = 4$ cm.

- (i) **Using a ruler and compasses only**, construct triangle RST .
 Leave in your construction arcs.
 The line RS has been drawn for you.



[2]

- (ii) Measure the distance from S to the midpoint of RT .
 Give your answer in millimetres.

..... mm [1]

- (b) Town A is 8.5 cm from town B on a map.
 The scale of the map is 1 : 50 000.

Calculate the actual distance from town A to town B .
 Give your answer in kilometres.

..... km [2]

(c)

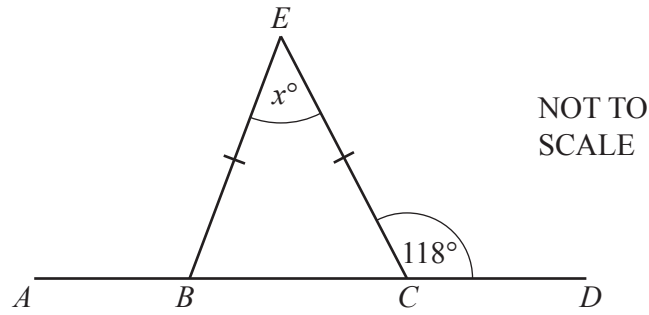

The diagram shows triangle BCE and a straight line $ABCD$.
 $BE = CE$ and angle $DCE = 118^\circ$.

Find the value of x .

$x = \dots\dots\dots$ [2]

(d)

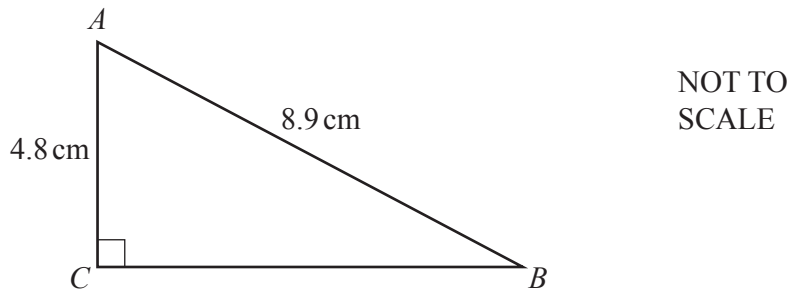

The diagram shows a right-angled triangle ABC .

Show that BC is 7.5 cm, correct to 2 significant figures.

[3]

Question 9 is printed on the next page.

9 Triangles A , B and C are shown on the grid.

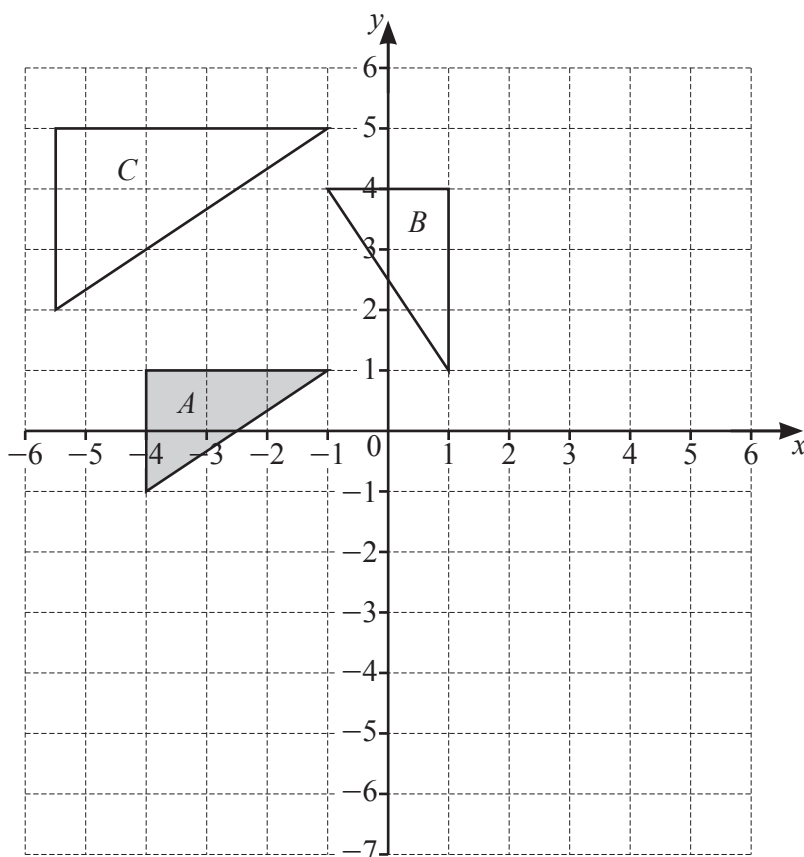

(a) Describe fully the **single** transformation that maps triangle A onto triangle B .

.....
 [3]

(b) Describe fully the **single** transformation that maps triangle A onto triangle C .

.....
 [3]

(c) On the grid, translate triangle A by the vector $\begin{pmatrix} 6 \\ -4 \end{pmatrix}$. [2]

(d) On the grid, reflect triangle A in the line $y = -2$. [2]

Permission to reproduce items where third-party owned material protected by copyright is included has been sought and cleared where possible. Every reasonable effort has been made by the publisher (UCLES) to trace copyright holders, but if any items requiring clearance have unwittingly been included, the publisher will be pleased to make amends at the earliest possible opportunity.

To avoid the issue of disclosure of answer-related information to candidates, all copyright acknowledgements are reproduced online in the Cambridge Assessment International Education Copyright Acknowledgements Booklet. This is produced for each series of examinations and is freely available to download at www.cambridgeinternational.org after the live examination series.

Cambridge Assessment International Education is part of Cambridge Assessment. Cambridge Assessment is the brand name of the University of Cambridge Local Examinations Syndicate (UCLES), which is a department of the University of Cambridge.